



User Manual

V1.0

M6 Series | **Dome Thermal
Camera**

M6S/M6D/M6T

Tip:

Please read this guide before using the product, and keep the guide for future reference.

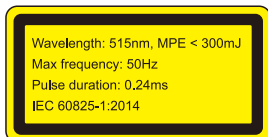

RoHS



M6 Series

User Manual



1	Package Contents	1-1
2	Components	2-2
3	Specifications	3-4
4	Installation	5-6
5	Wiring Guide	7-8
6	InfiRay Outdoor APP Operation	9-18
7	Precautions	19-19
8	Important Safety Information	20-22
9	Legal and Regulatory Information	23-25

Package Contents

- M6 Series Dome Thermal Camera
- Ethernet cable
- Multi-functional cable
- Cigar lighter cable
- Base
- Suction cup subassembly ×4
- Mounting tools ×2
- Screws

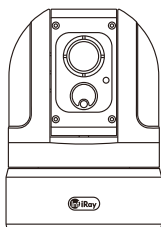

M6 Series

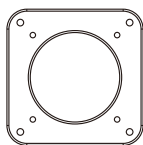

Base

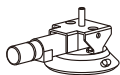

Suction cup subassembly

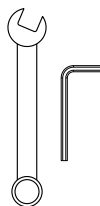

Mounting tools

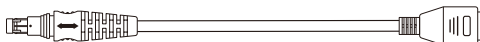

Ethernet cable



Cigar lighter cable



Multi-functional cable

Components

1. Objective lens
2. Laser pointer
3. Laser rangefinder
4. Ethernet interface
5. WIFI antenna
6. Multi-Functional Cable Interface

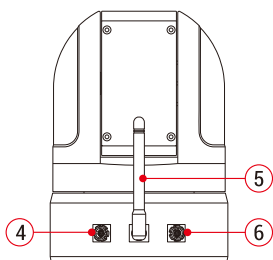
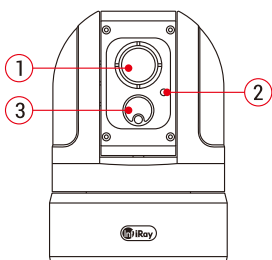

Specifications

Model	M6S		M6D		M6T	
	M6S19	M6S25	M6D19	M6D25	M6T19	M6T25
Microbolometer						
Detector	640×512, VO _x Microbolometer					
Pixel size	12 μm					
Spectrum Range	8 ~ 14 μm					
NETD	≤ 50 mk					
Frame Rate	50 Hz					
Optical Specifications						
Objective lens	19 mm	25 mm	19 mm	25 mm	19 mm	25 mm
FOV, °	22.9×18.4	17.5×14.0	22.9×18.4	17.5×14.0	22.9×18.4	17.5×14.0
imaging Range	≥3m					
Digital Zoom	×1 / ×2 / ×4					
Image Processing	Digital filter noise reduction / digital detail enhancement					
Camera						
Azimuth Range	360° continuous rotation					
Pitch Range	-90° ~ +90°					
Motor	Brushless motor direct driving, without transmission mechanism, with low noise and stable performance					
Number of Preset Points	Up to 8					
Auto Cruise	Trace: Cruise in the order of preset points					
Gyro Stabilization	Azimuth and pitch two-axis gyro stabilization supported					

Model	M6S		M6D		M6T	
	M6S19	M6S25	M6D19	M6D25	M6T19	M6T25
Function Features						
Laser Pointer	×		✓		✓	
Laser Rangefinder	×		×		✓	
Power Supply						
Power	DC 12V					
Power Consumption	Normal 4W, peak 24W					
Interfaces						
WiFi	Support					
Ethernet	Support					
Network Video Output	Browser page output and H.264 network video stream supported					
Analog Video Output	PAL analog video output					
Control	RS485 PELCO-D protocol and network control interface (InfiRay Outdoor App supported)					
Environmental/Physical Parameters						
Window Defrosting	Automatic defrost depending on the ambient temperature after startup					
Operating Temp. Range	-20~60°C					
IP Rating	IP56					
Dimensions	Φ133mm, 188mm high					
Weight	2 kg					
Mounting Method						
Suction Cup	Supported					
Fixed Mounting	With mounting bracket					

Installation

The M6 series can be fixed by sticking suction cups or mounting a bracket.

Before installation, fit the **base (7)** to the bottom of the M6 series dome camera with M5×12 inner hexagon screws (**8**).

Installation with suction cup subassemblies

- Take out the 4 suction cup subassemblies (**9**) from the accessories.
- Align the screw (**10**) on the top of the suction cup subassembly (**9**) with the circular hole on the base, and insert it into the circular hole from the bottom of the base.
- After the 4 suction cup assemblies are fitted to the circular holes, fasten these screws (**10**) with nuts (**11**).
- Clean the vehicle roof, and place the dome camera fitted with suction cups in a proper position on the roof.
- Press the suction cups tightly against the roof and squeeze the air pumps on the suction cups until the red circles (**12**) on the air pumps shrink into the air pumps.
- Shake the dome camera to ensure that it is fixed firmly.
- If the dome camera is to be used on the roof for a long time, please regularly check whether the red circles (**12**) on the air pumps shrink into the cylinders.

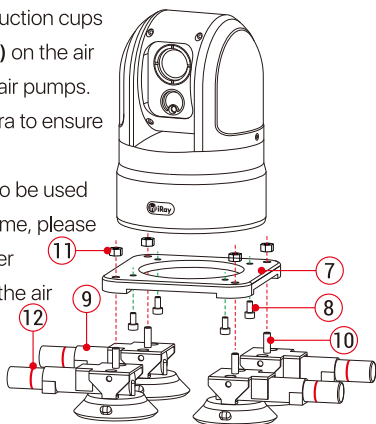

Installation with bracket

- Prepare two vehicle-mounted cross-bar brackets (13) (to be purchased by users).
- Find the 4 square screws (14) from the accessories, and insert them into the T-slots of the cross-bar brackets (13). Each bracket matches two screws.
- Fix the two cross-bar brackets (13) on the roof rack in parallel, with an interval of about 11cm.
- Adjust the position of the two square screws on each bracket so that they are spaced 11cm apart.
- Align and fit the four circular holes on the base to the four square screws on the brackets, then lock the screws with nuts (15). The installation is completed.

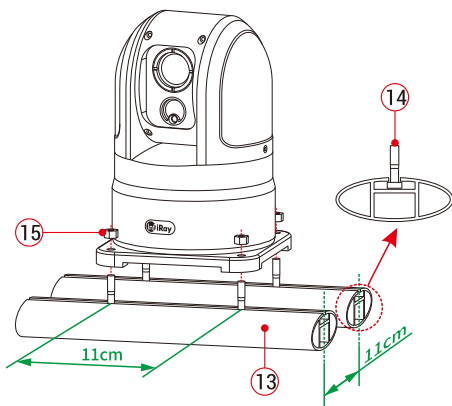

Note: it is recommended to adjust the lens of the dome camera to the front of the vehicle, and set it as the zero position after the device is powered on, referring to the APP- Zero position setting for details.

Wiring Guide

The M6 series dome camera has two interfaces, an Ethernet interface (4) and a multi-functional cable interface (6). The wiring diagrams are as follows:

Ethernet interface

The Ethernet interface connects the dome camera to a computer through the matching Ethernet cable (16). This port is mainly for professional applications and is described here.

Multi-functional interface

The multi-functional cable interface is for the power supply and control of the dome camera. The dome camera is powered and controlled through the matching 1-for-3 multi-functional cable (17).

- Insert the single interface end (J1) of the 1-for-3 multi-functional cable into the multi-functional cable interface (6) of the dome camera.
- Connect the other end to the corresponding device interface to supply power and control the dome camera.
- The multi-functional cable has three external interfaces to adapt to three categories of devices:
 - **BNC interface** (for analog video output): Insert the analog video BNC end (J2) of the multi-functional cable into the BNC interface of the monitor, and connect the power supply (DC 12V) to the display screen. The dome camera automatically turns on and outputs analog videos about 30 seconds later (that is, transmits images to the monitor).
 - **DC 12V power interface** (for power supply to the vehicle-

mounted cigar lighter): Connect the DC 12V power interface (**J3**) of the multi-functional cable to the power connector of the matching cigar lighter cable (16). Insert the other end of the cigar lighter cable (16) into the interface of the cigar lighter. When the vehicle is ignited, it supplies power to the dome camera. You can control the dome camera through the mobile App. For details, refer to the section App Control.

- **Control interface** (for monitoring keyboard control): Connect the control interface (**J4**) of the multi-functional cable to the corresponding interface of the monitoring keyboard (to be purchased separately). After the power supply is connected, you can control the interface through the rocker on the monitoring keyboard. For specific operations, refer to the instructions on the monitoring keyboard.

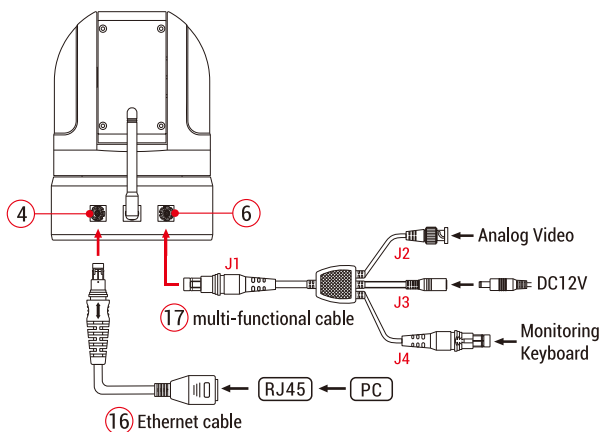

InfiRay Outdoor APP Operation

When the M6 Series Dome Camera is connected to the power supply, you can control it remotely through the InfiRay Outdoor APP.

Connect with the InfiRay Outdoor

- Download and install the InfiRay Outdoor app from the official website or app store, or scan the QR code (based on your mobile OS) to download directly.



- After installation, open InfiRay Outdoor. On the home screen, tap the **ViewFinder** icon at the bottom. A "Phone connect Device WiFi" prompt box is displayed.

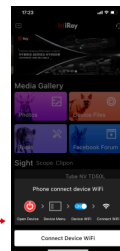
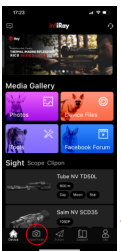



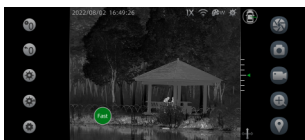



- Tap "**Connect Device WiFi**". The WLAN interface is automatically displayed. Select the Wi-Fi name of the dome camera and enter the password.
- By default, the WIFI name is InfiRay_M6X_xx (X_xx indicates the device type and SN) and the password is infiraym6s.
- Return to the home screen of the App. Tap the **ViewFinder** icon to enter the operating interface of the dome camera directly.



Functions

Display Status



1. System time (synchronize the system time on the App)
2. Current zoom status (1x, 2x, or 4x)
3. Wi-Fi connection status ( : Wi-Fi is on;  : Wi-Fi is off)
4. Current image mode (W: white hot, B: black hot, R: red hot, C: pseudo-color)
5. Laser pointer status ( : On;  : Off)
6. Current azimuth of the dome camera (The green arrow indicates the current azimuth, and it supports 360° rotation.)
7. Current pitch angle of the dome camera (The green arrow indicates the current pitch angle, and it supports rotation from -90° to 90°)
8. Current stabilization status (when the image stabilization is enabled,  : azimuth stabilization is on,  : pitch stabilization is on,  : both azimuth stabilization and pitch stabilization are on)
9. Controller (control the rotation angle and speed)

Operating Instruction



Controller - Control the rotation angle and speed

- Drag the **Controller** in the lower left corner of the screen to rotate the dome camera.
- When dragging the **Controller**, a circular dragging area is automatically displayed under the **Controller** that means the **Controller** can only be dragged in this area.
- When dragging the **Controller**, the azimuth and pitch angles on the right side will vary accordingly.
- Double-click the **Controller** to set the rotation speeds of the dome camera, including Fast, Mid and Slow in turn.

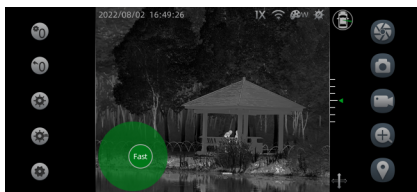

Zero Position Setting - Set the current position of the dome camera to zero

- It is recommended to set a zero position immediately after the installation. Generally, the front of the vehicle is zero position.
- When installing the dome camera, adjust the lens to point to the vehicle head.
- After the camera is on, tap the icon of **Zero Position Setting** to set the current position to the zero position.
- You can also adjust the **Controller** to set a proper position, and save it as the zero position.

① **Return to Zero Position** - Quickly return to camera to the zero position

- When a zero position is preset, no matter where the dome camera rotates, tap the icon of **Return to Zero Position**, the camera will quickly return to the preset zero position.

② **Laser Indicator** - Turn on/off the laser indicator

- Tap the icon of **Laser Indicator** to turn on the laser indicator. A green cross cursor is displayed on the interface.
- Tap the icon again to turn off the laser indicator. The laser cursor disappears.
- When the laser pointer is turned on/off, the icon in the status bar on the top changes accordingly.

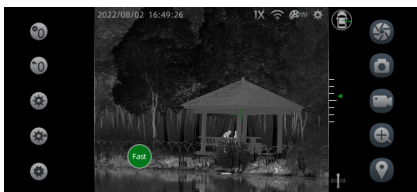

③ **Laser Rangefinder** - Turn on/off the laser rangefinder

- Tap the icon of **Laser Rangefinder** to turn on the laser rangefinder function. A blue square rangefinder cursor is displayed on the interface.
- An independent PIP window is displayed in the lower right corner of the interface, showing local details centered on the rangefinder cursor.
- The upper right corner of the PIP window shows the distance to the target selected by the rangefinder

canceled and return to the submenu interface.



Image Mode - Select the image mode

- In the submenu of Settings, tap this icon of **Image Mode** to display four options of image mode, including white hot (W), black hot (B), red hot (R), and pseudo-color (C).
- Tap the icon of the image mode to select one mode. The change of the image color will occur immediately after pressing the icon and the icon in the status bar in the upper right corner will change accordingly.
- Tap other icons to select other function and exit the setting of image mode.

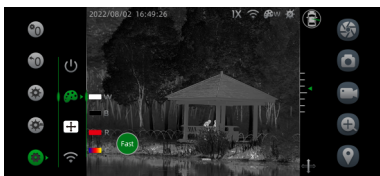

Stabilization – Turn on/off the azimuth stabilization and pitch stabilization functions

- In the submenu of Settings, tap the icon of **Stabilization** to display the options of the stabilization.

- There are two options – azimuth stabilization (↔↕) and pitch stabilization (↕↔).
- The two stabilization functions are independently controlled. You can tap the icon to turn on/off the corresponding function.
- When the icon is green, it means the stabilization function is on; when the icon is gray, the function is off. The stabilization status icon in the lower right corner changes accordingly.
- When both the azimuth and pitch stabilization functions are off, the stabilization status icon in the lower right corner disappears.
- Tap other icons to set parameters and exit the stabilization interface.



📶 **Wi-Fi Setting** - Set the name and password of Wi-Fi

- In the submenu of Settings, tap the icon of **Wi-Fi** to enter the Wi-Fi setting interface.
- The current Wi-Fi name (👤) and password (🔑) are displayed on the interface.
- Tap the corresponding positions to customize the Wi-Fi name and password.
- After customization, tap ✅ to save the parameters and restart the device. Tap ↻ to restore the Wi-Fi name and password to the factory default settings.

Or tap  to cancel the operation.

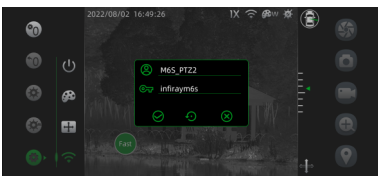

Shutter Correction - Calibrate the image

- If images degrade, tap the icon of **Shutter Correction** to calibrate the image that makes image clearer.

Photographing

- Tap the icon of **Photographing** to take photos.
- During photographing, the icon of "Success" will flash on the center of the screen.
- when the icon of "Success" disappears, photographing is finished.

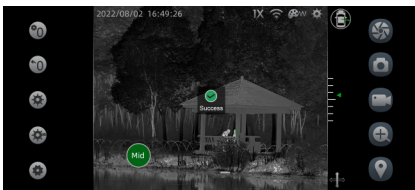

Video Recording

- Tap the icon of **Video Recording** to start the video recording function.
- A prompt for the recording time is displayed at the top of the screen.
- Tap the icon of **Video Recording** again to end the video recording.



- The video will be saved in the built-in memory space.



Digital Zoom

- Tap the icon of **Digital Zoom** to switch the digital zooms (1×, 2×, and 4×) circularly.
- The zoom icon in the status bar on the top changes accordingly.

Preset Point - Setting the cruise positions of the dome camera

- Tap the icon of **Preset Point** to enter the submenu for configuring a preset point.
- Drag the **Controller** on the home screen to the appropriate position. Tap the icon  on the bottom of the submenu interface to add a preset point.
- Repeat the operation to add the next preset point. You can set up to 8 preset points in ascending order.
- When the digital button changes from gray to green, it indicates this position is set with preset points.
- Tap the digital button, and the dome camera moves to the corresponding preset points.
- To delete preset points, tap the icon  on the bottom of the submenu interface. The preset points will be deleted in reverse order.
- Tap the icon  on the bottom of the submenu interface.

- The dome camera will start cruising in the order of the preset points, and when it reaches to the preset points, it will stop for about 5 seconds.
- When the cruise is enabled, the icon turns green, and the cruise icon in the status bar on the top flashes.
- To exit the cruise function, re-tap the cruise button, tap the digital button at the preset point or drag the control disk to rotate the dome camera.



Precautions

- After the camera is installed on the roof, you need to rotate the camera in the direction right ahead of the vehicle head and tap the Setting Zero Position button. At the moment, the angle of the azimuth can return to zero and an accurate degree of azimuth angle can be displayed.
- When the dome camera is fixed by sticking suction cups, these suction cups must be pressed tightly on the roof, otherwise, air leakage may occur. At the same time, the air pump must be pressed to the extreme position.
- Before long-distance driving, you are advised to occasionally check if the air pump pops up on the way.
- Do not point the infrared lens directly to sunlight as far as possible. Rotate the lens to the lowest positions before each power-off.
- When enabling the laser rangefinder function and turning on the laser pointer, do not point them directly to human eyes or faces.

Important Safety Information

Environmental influences

Warning! Never point the lens of the device directly at intense heat sources such as the sun or laser equipment. The objective lens and eyepiece can function as a burning glass and damage the interior components.

Risk of swallowing

Do not place this device in the hands of small children. Incorrect handling can cause small parts to come loose which may be swallowed.

Safety instructions for use

- Do not expose the device to fire or high temperatures.
- Do not expose your device to extreme temperatures lower than - 20°C and higher than + 60°C.
- The recommended temperature for using this product is -20° to +60°. Temperature exceeding this range will affect the service life of the product.
- Always store the device in a dry, well-ventilated space.
- If the device has been damaged, send the device to our after-sales service for repair.

User information on the disposal of electrical and electronic devices (private households)



The WEEE symbol on products and/or accompanying documents indicates that used electrical and electronic products must not be mixed with ordinary household waste. For proper treatment, recovery and recycling,

take these products to the appropriate collection points where they will be accepted without charge. In some countries, it may also be possible to return these products to your local retailer when you purchase a corresponding new product. The proper disposal of this product serves to protect the environment and prevents possible harmful effects on human beings and their surroundings, which may arise as a result of incorrect handling of waste.

More detailed information on your nearest collection point is available from your local authority. In accordance with state legislation, penalties may be imposed for the improper disposal of this type of waste.

For business customers within the European Union

Please contact your dealer or supplier regarding the disposal of electrical and electronic devices. He will provide you with further information.

Information on disposal in other countries outside of the European Union

This symbol is only applicable in the European Union. Please contact your local authority or dealer if you wish to dispose of this product and ask for a disposal option.

Intended use

The device is intended for displaying heat signatures during nature observation, remote hunting observations and for civil use. This device is not a toy for children.

Use the device only as described in this user manual. The manufacturer and the dealer accept no liability for damages which arise due to non-intended or incorrect use.

Function test

- Before use, please ensure that your device has no visible damage.
- Test to see if the device displays a clear, undisturbed image.

Legal and Regulatory Information

Wireless transmitter module frequency range:

WLAN: 2.400-2.483GHz (For EU)

Wireless transmitter module power < 18dBm (only for EU)



Hereby, InfiRay Technologies Co., Ltd. declares that the radio equipment type M6 Series Dome Thermal Camera is in compliance with the Directives 2014/53/EU. The full text of the EU declaration of conformity as well as additional information are available at:
www.infirayoutdoor.com.

This device may be operated in all member states of the EU.

FCC Statement

FCC ID: 2AYGT-9000

Labeling requirements

This device complies with part 15 of the FCC Rules. Operation is subject to the following two conditions: (1) This device may not cause harmful interference, and (2) this device must accept any interference received, including interference that may cause undesired operation.

Information to the user

Any Changes or modifications not expressly approved by the party responsible for compliance could void the user's authority to operate the equipment.

Note: The manufacturer is not responsible for any radio or TV

interference caused by unauthorized modifications to this equipment. Such modifications could void the user's authority to operate the equipment.

Note: This equipment has been tested and found to comply with the limits for a Class A digital device, pursuant to part 15 of the FCC Rules. These limits are designed to provide reasonable protection against harmful interference when the equipment is operated in a commercial environment. This equipment generates, uses, and can radiate radio frequency energy and, if not installed and used in accordance with the instruction manual, may cause harmful interference to radio communications. Operation of this equipment in a residential area is likely to cause harmful interference in which case the user will be required to correct the interference at his own expense.

This device meets the government's requirements for exposure to radio waves. The guidelines are based on standards that were developed by independent scientific organizations through periodic and thorough evaluation of scientific studies. The standards include a substantial safety margin designed to assure the safety of all persons regardless of age or health.

The highest SAR value reported under this standard during product certification for use at the ear is 0.5W/kg and when properly worn on the body is 0.49W/kg. This device was tested for typical body-worn operations with the back of the handset kept 0.5cm from the body.

Body-worn Operation

This device was tested for typical body-support operations. To comply with RF exposure requirements, a minimum separation distance of 0.5cm must be maintained between the user's body and the handset, including the antenna. Third-party belt-clips, holsters, and similar accessories used by this device should not contain any metallic components. Body accessories that do not meet these requirements may not comply with RF exposure requirements and should be avoided. Use only the supplied or an approved antenna.



InfiRay Technology Co., Ltd.

Add.: 11th Guiyang Street, YEDA, Yantai 264006, P.R. China

Tel: 0086-400-999-3800

Web: www.infirayoutdoor.com

Email: infirayoutdoor@infiray.com